

Washer-Extractor

FM7 Computer Programming and Operating Instructions

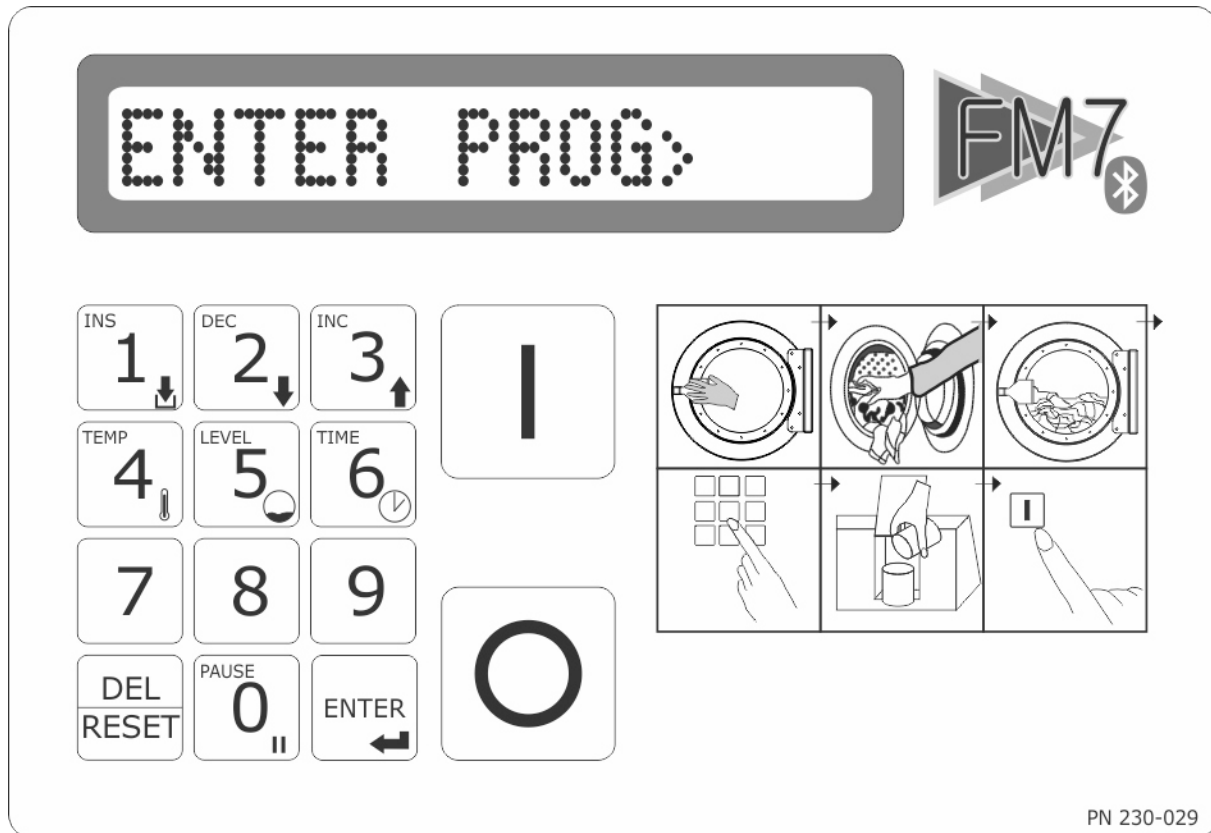

B&C Technologies

Panama City Beach, FL

(850) 249-2222

www.bandctech.com

service@bandctech.com

Table of Contents	Introduction	
	Customer Service	3
	Replacement Parts	3
	Quick Reference	4
	Safety Information	
	Key Symbols	5
	Important Safety Information	6
	Programming	7
	Agitation Programming	8
	Agitation Flow Chart	10
	Cycle Programming	14
	Wash Program Creation	19
	Wash Program Flowchart	21
	Cycle Execution	22
	Malfunction Alarms	24
	Service Functions	25
	Metric Conversion Chart	27
	Centigrade to Fahrenheit	28
	Centimeters to Inches	29
	Blank Programming Chart	30
	Water Level Guide	31
	Speed Guide	32
	Appendix A - Build a Heat Cycle	33
	Appendix B - Chemical Hold	34

B&C Technologies

Panama City Beach, FL

(850) 249-2222

(850) 249-2226 FAX

www.bandctech.com

Introduction

FM7 Computer

The FM7 Computer is a powerful and programmable solid state controller. Up to 30 programs, each with up to 15 cycles can be programmed. In addition, the FM7 can display 5 languages - English, Italian, German, Spanish and French. The water level can be programmed, and is accurate to 1 cm (0.4 in). Spin speeds are fully programmable in RPM. In the event of power failure, the operator is prompted to continue the cycle, or abort it.

Keypad

 Number key, Insert Key. Enables a new cycle to be inserted in an existing program during programming. During operation, press and hold for cylinder RPM.

 Number key, Decrement Key. Lowers the current value during programming mode.

 Number key, Increment Key. Raises the current value during programming mode. If pressed simultaneously with the TEMP or LEVEL key, allows temporary modification.

 Number key, Temperature Key. Allows temporary modification of the target temperature if used with the INC and DEC keys. Displays current temperature in wash cylinder.

 Number key, Level Key. Allows temporary modification of the target water level if used with the INC and DEC keys. Displays current water level in wash cylinder.

 Number key, Time Key. Displays the watch dog timer value for the current step.

 7

 8 Number keys

 9

 Number key, Pause Key. If pressed during operation, pauses the wash program indefinitely. Not active during distribution or spin.

 ENTER Confirms settings in creation and editing of wash programs. During operation, shows the current segment or program number.

 DEL Deletes any selection or setting.
RESET

 Terminates the current activity (operation or programming). While the machine is powered but not executing a program, can be pressed with RESET to see the current firmware version.

 Starts execution of the currently selected wash program. Restarts a paused program. When pressed with RESET, function codes can be entered to program and setup the machine. See the quick reference list on the next page.

The Advance key is now a hidden key, located between the Stop and Start buttons. Pressing this hidden key advances to the next program step. During final spin, the remainder of the spin is aborted. If pressed before starting a program, it allows the operator to begin the program at any segment. During programming, skips to the next segment.

Quick Reference

To perform these functions, press START and RESET together, then at the prompt (n?), key in the desired number, then press ENTER. Detailed explanation of each function starts on page 25.

Programming	
12	Programming cycles
27	Creation of Programs
45	Agitation profiles
144	FM7 communications mode
System Setup	
118	Disable Machine (Display shows ! - exclamation point)
181	Resets controller - erases all memory
201	Language option (1 - Italian, 2 - English, 3 - German, 4 - Spanish, 5 - French)
205	16 or 24 outputs (B&C uses the 24 output version)
207	Maximum RPM
209	Temperature Hysteresis (min 1 deg, max 10 deg) Default is 3 deg.
210	Display temperature in degrees C
211	Display temperature in degrees F
212	Maximum water level that can be set (10 - 100 cm)
213	Minimum water level for heating (2 - 30 cm)
214	Display number of hours of operation
215	Display total number of washes
216	Display number of washes since the last service alarm
217	Reset Service Alarm
218	Display and set number of washes until service alarm
219	Spin slow down time (40 - 200 sec)
220	Erases Programs and cycles
225	Disables Advance Key
230	Maximum water level allowed during spin (2 - 60 cm)



Highlighted items are safety related and SHOULD NOT BE CHANGED!

DO NOT ALTER THESE VALUES WITHOUT CONSULTING B&C TECHNOLOGIES OR A QUALIFIED TECHNICIAN!

Key Symbols

Anyone operation or servicing this machine must follow the safety rules in this manual. Particular attention must be paid to the DANGER, WARNING, and CAUTION blocks which appear throughout the manual



The lightning flash and arrowhead within the triangle is a warning sign alerting you of the presence of dangerous voltage.



The exclamation point within the triangle is a warning sign alerting you of important instructions concerning the machine and possible dangerous conditions.



This warning symbol alerts you to the presence of possible dangerous drive mechanisms within the machine. Guards should always be in place when the machine is in operation. Be careful when servicing any drive mechanism.



This warning symbol indicates the presence of possibly dangerous chemicals. Proper precautions should be taken when handling corrosive or caustic material.



This warning symbol indicates the presence of hot surfaces that could cause serious burns. Stainless steel and steam lines can become extremely hot and should not be touched.



This warning symbol indicates the presence of possible dangerous pinch-points. Moving mechanical parts can crush an/or sever body parts.



Before servicing any equipment, make certain it is disconnected from the electrical power source. Never allow operation of the machine when any safety device is malfunctioning. Never bypass safety devices.

Important Safety Information

SAFETY CHECK LIST

Before Initial start up of a B&C washer – extractor perform the following safety check:

- A. Make sure all electrical and plumbing connections have been made in accordance with applicable codes and regulations.
- B. Make sure the machine is grounded electrically.
- C. Make sure the machine has flexible water fill and drain connections of the correct size, length and type, with no kinks, and that they are securely attached and/or clamped.
- D. Make sure any transport brackets have been removed.

Before machine is placed in operation, the door safety interlock must be checked for proper operation as follows:

- A. When the washer is energized electrically and in operation, the loading door must be locked in the closed position. Verify this by attempting to open the loading door when the machine is operating. If necessary, check the door safety interlock and sensors for proper operation. Consult the service manual, or call a qualified service technician if necessary.
- B. When the washers loading door is open, it should not be possible to start the machine. Verify this by attempting to start the washer with the door open. Also, close the door without locking it and verify that it is not possible to start the machine with the door not locked. If necessary, check the door lock sensors for proper operation. Consult the service manual, or call a qualified service technician. If additional information is required, contact your local distributor or call the manufacturer of the machine.



Before servicing any equipment, make certain it is disconnected from the electrical power source. Never allow operation of the machine when any safety device is malfunctioning. Never bypass safety devices.

Programming

Programming the FM7 takes place on three levels:

1. Programming agitation (Function 45)
Allows 15 different agitation profiles to be created. For each profile, the clockwise rotation time, the counterclockwise rotation time and the pause time can be programmed. (Factory defaults are shown on page 9).
2. Programming cycles (Function 12)
Each grouping of steps creates a sequence of events in which various functions can be activated or deactivated (drain, cold fill, spin, etc.). Going from one step to another requires reaching a water level, temperature, or a time value. There are five different programmable cycle types: Prewash, Wash, Rinse, Spin and Unroll (Shakeout). Each cycle can be assigned a number between 1 and 99. (See the FM7 Stock Programs Listing for details on factory settings).
3. Wash Programs Creation (Function 27)
Consists of putting the various cycles as programmed above together to form a complete wash program. Up to 30 programs can be stored, each with 15 cycles. (See the FM7 Stock Programs Listing for details on factory settings).

A Note about Programming the FM7:

The FM7 comes from the factory with several stock programs already entered. See the separate document, FM7 Stock Program List for details. It is by far easier to modify these existing cycles and programs than to start from nothing and create your own.

Note that Programs are made up of cycles, and cycles are made up of steps. The wash programs are simply a series of cycles performed in order by the control. The cycles, contain the steps in which wash functions are executed - things like fill the machine to a certain level, dose chemicals, agitate the load, etc. If you wish to modify a water level, you will need to determine the appropriate cycle to modify, and the step within that cycle. The FM7 Stock Program List will help you determine which cycle to edit.

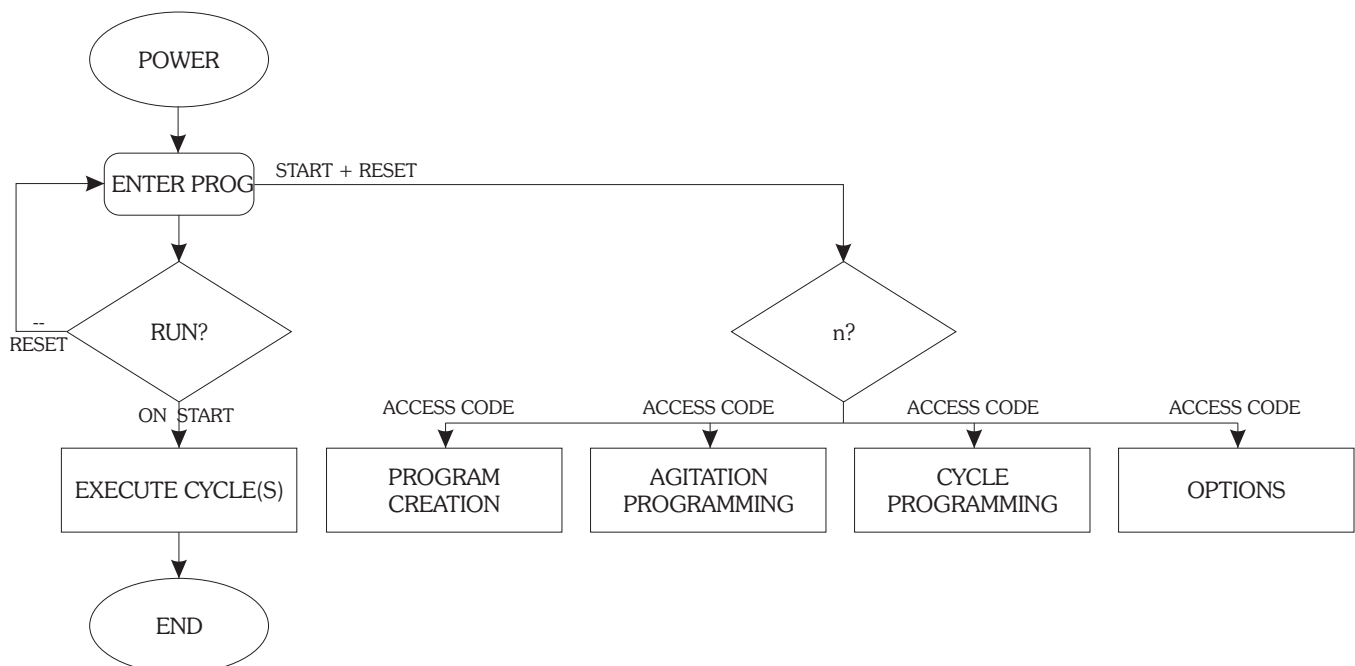

Programming

Agitation Programming

To access the agitation profile programming mode, press START and RESET together. The display shows:

n?

Enter 45 at this prompt, followed by the ENTER key. For two seconds, the display will show:

EDIT AGITATION>

You are then asked to enter the motor routine number to be programmed (1 - 15).

AGITATION No.

You may now enter the number and press the ENTER key. There are now two cases:

1. The motor routine does not exist.
2. The motor routine does exist.

New Agitation Routine

In this case, you are prompted to enter a forward rotation time with this message:

FWD T = S

Enter the desired time in seconds (0 through 239), followed by the ENTER key. The display will change to:

PAUSE T = S

Enter the desired time in seconds (0 through 239), followed by the ENTER key. The display will change to:

REV T = S

Enter the reverse time in seconds (0 through 239), followed by the ENTER key. The display will show:

SAVE?

Pressing ENTER will store the motor timing routine and the display will change to request a new access code:

n?

Enter 45 at the prompt to program additional motor timing sequences as required. Pressing RESET instead of ENTER will exit programming.

Editing an Existing Routine

If the motor routine number you entered is already present, the display will show:

NOT BLANK!

Pressing the ENTER key again displays the forward rotation time:

FWD T = XXs

Pressing the INC and DEC keys allow you to step through the values for Forward, Pause, and Backwards. Pressing ENTER will allow you to modify the value on the display

After having viewed or modified the backwards value, pressing the INC or ENTER key displays:

SAVE?

Pressing ENTER confirms the changes made (if any) and exits programming

Pressing RESET exits the current programming mode and leaves the existing values as they were.

Programming

Agitation Programming continued

Notes on Agitation Programming

There are a number of different modes available for motor programming:

1. Forwards - Pause - Backwards

FWD T = XXs

PAUSE T = XXs

REV T = XXs

2. Forwards - Pause

FWD T = XXs

PAUSE T = XXs

REV T = S0

3. Forwards

FWD T = XXs

PAUSE T = S0

4. Pause - Backwards

FWD T = S0

PAUSE T = XXs

REV T = XXs

5. Backwards

FWD T = S0

PAUSE T = S0

REV T = XXs

The minimum pause time that can be programmed between forward and backwards is 2 seconds. The maximum time is 239 seconds.

Cylinder speed is programmed during cycle programming. In this mode, each step can be programmed with different values if desired.

B&C Stock Agitation Assignments

Agitation	Forward	Pause	Reverse
1	16	4	16
2	4	16	4
3	5	115	5
14	0	0	1
15	1	0	0

Agitation 1 - used for normal wash agitation.

Agitation2 - used for gentle wash agitation.

Agitation3 - used for soak formulas

Agitation14 - Used for Unroll cycles (reverse only)

Agitation15 - Used for Spin cycles (forward only)

Programming

Agitation Programming Flow Chart

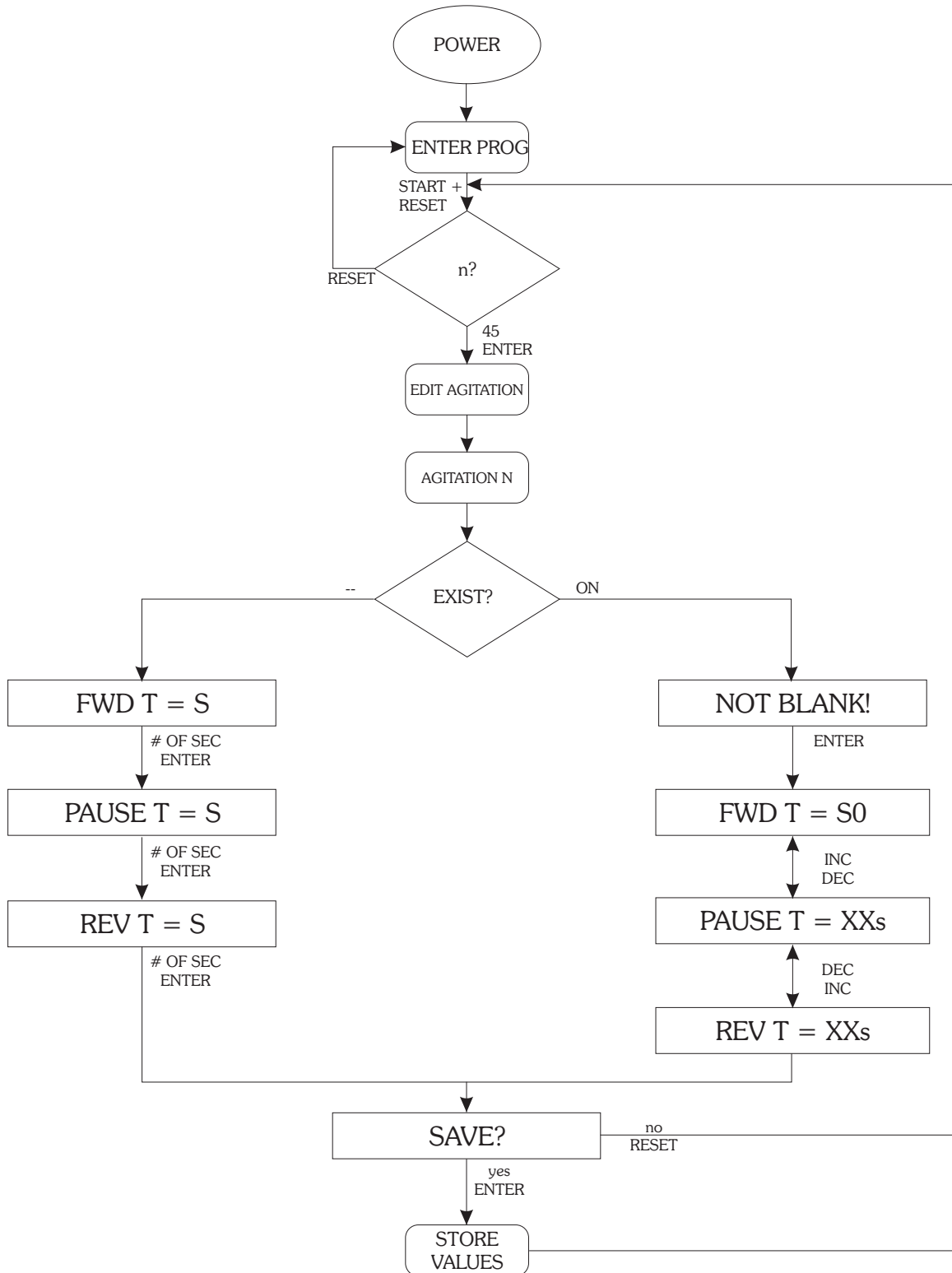

Cycle Programming Sequence

To turn on a function, press Enter, to turn off a function press Reset. Press Enter to edit a numerical value (RPM, Time, etc.). Note: Setting a function to zero DOES NOT disable that function.

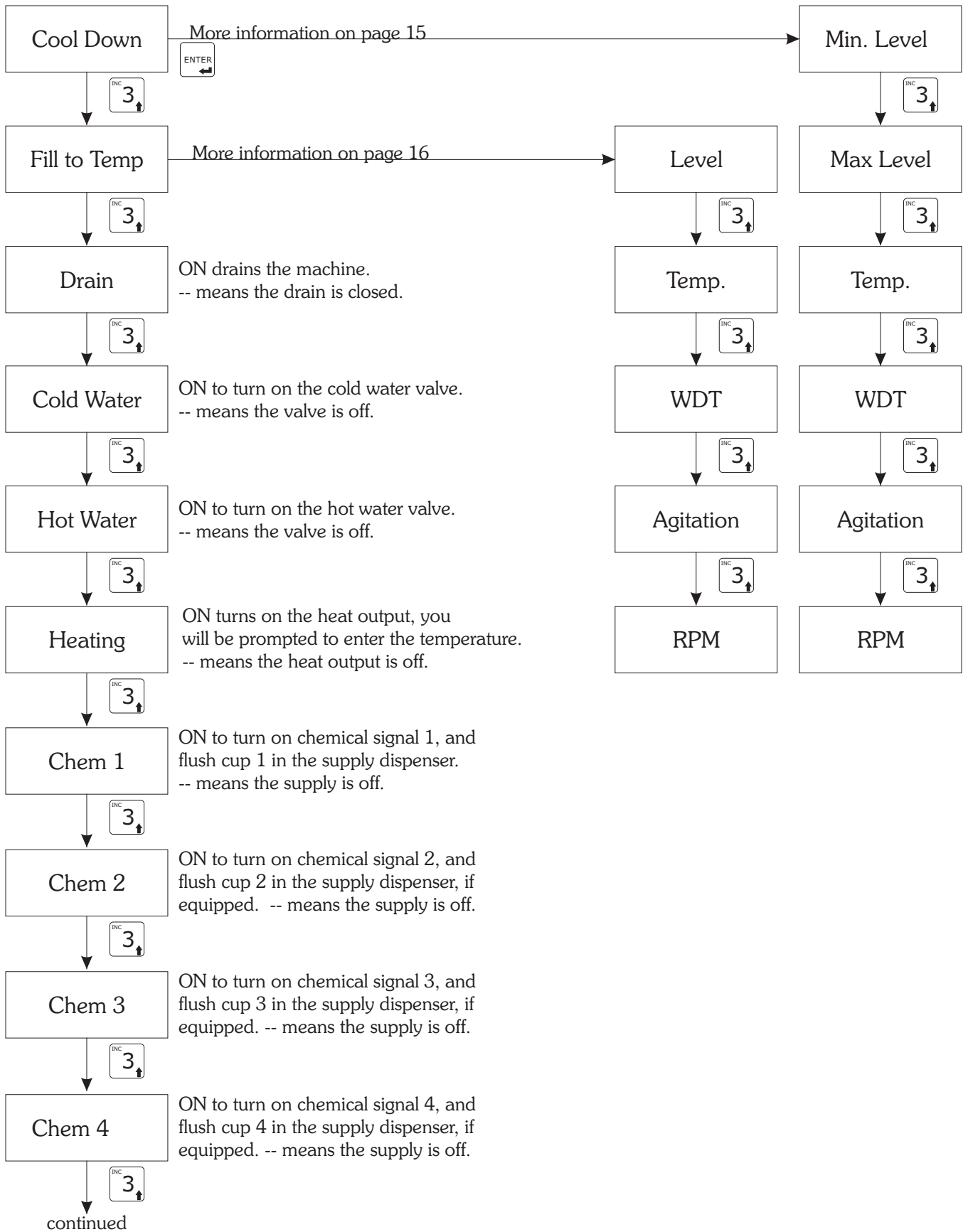

Cycle Programming Sequence

To turn on a function, press Enter, to turn off a function press Reset. Press Enter to edit a numerical value (RPM, Time, etc.). Note: Setting a function to zero DOES NOT disable that function.

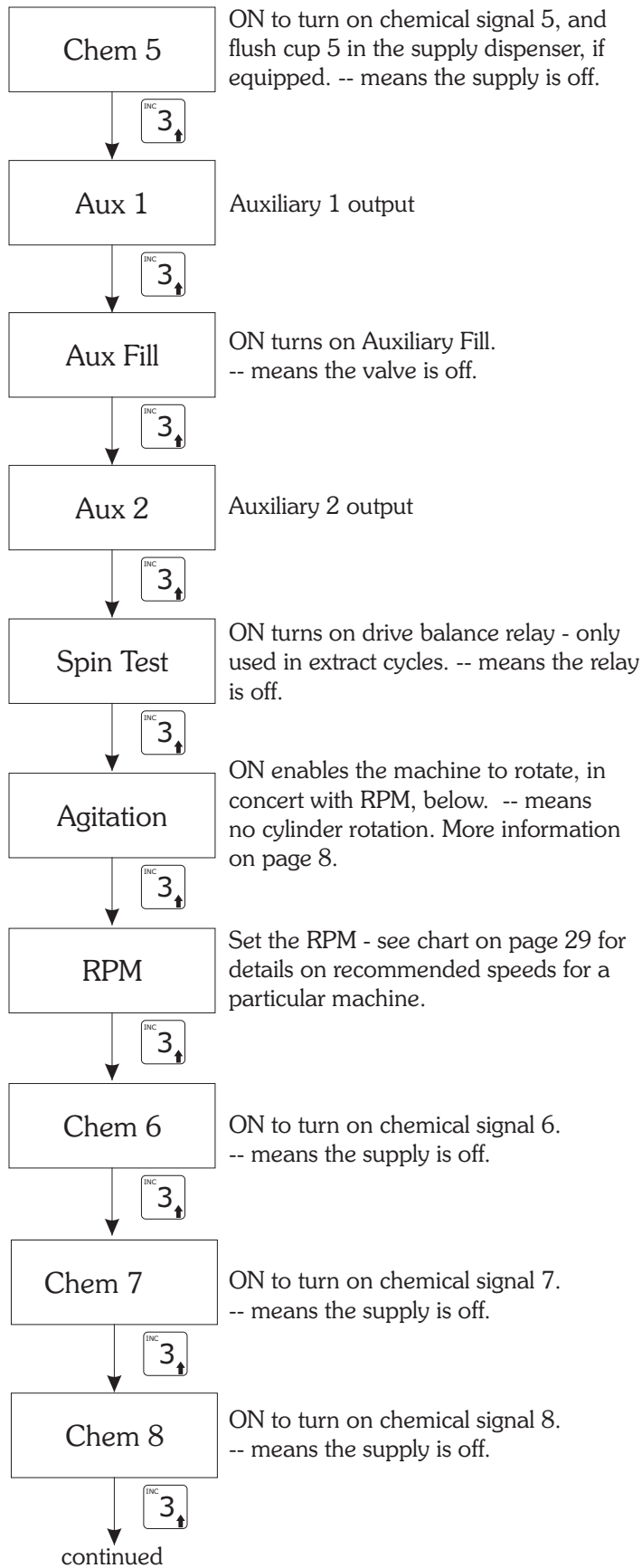

Cycle Programming Sequence

To turn on a function, press Enter, to turn off a function press Reset. Press Enter to edit a numerical value (RPM, Time, etc.). Note: Setting a function to zero DOES NOT disable that function.

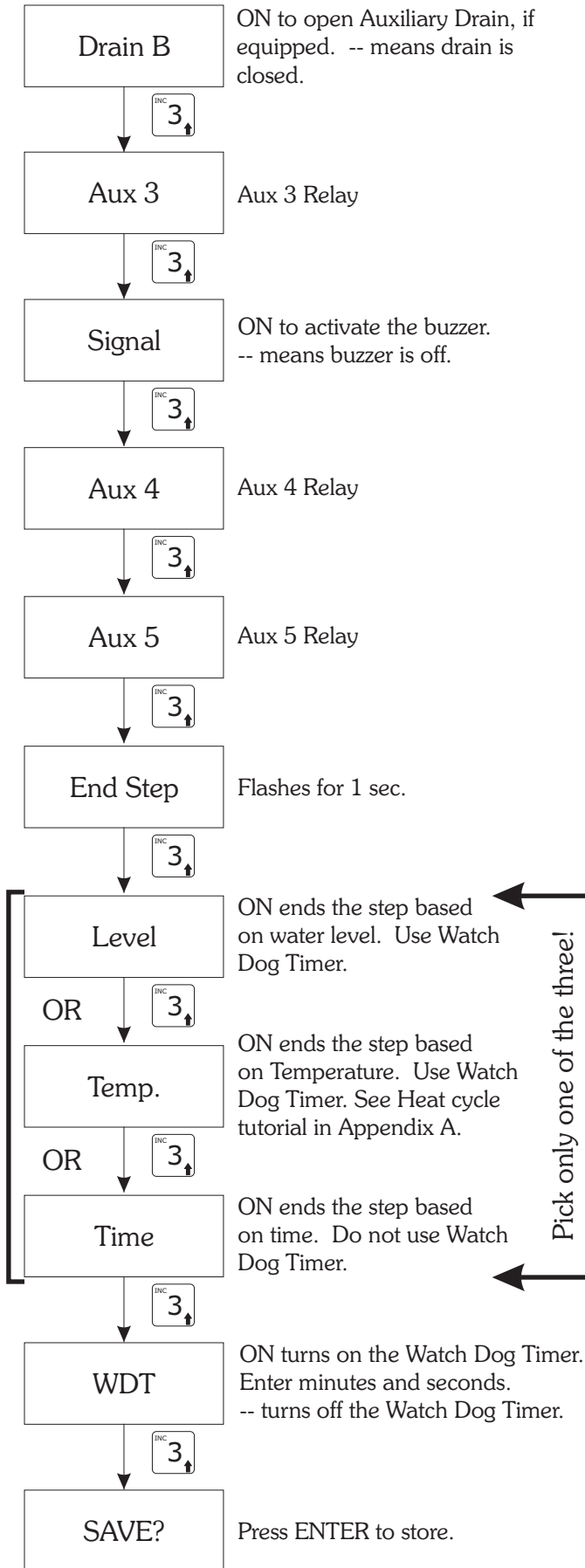

Example Cycle Construction:

Step 1 (Fill Step)

Turn on hot, cold or both.
Turn on Agitation, and enter RPM.
Turn on Level and enter water level (see chart, pg 31)
Turn on WDT and enter a time (9m, 0s typically)
Press enter to store.

Step 2 (Chemical Dose Step)

Turn on Chemical output
Turn on Agitation, and enter RPM.
Turn on Time and enter a time (ex: 0m, 10s)
Press enter to store.

Step 3 (Top off - make sure we are still at level)

Turn on hot, cold or both.
Turn on Agitation, and enter RPM.
Turn on Level and enter water level (see chart, pg 31)
Turn on WDT and enter a time (9m, 0s typically)
Press enter to store.

Step 4 (Wash/Agitation Time)

Turn on Agitation, and enter RPM.
Turn on Time and enter a time (ex: 9m, 30s)
Press enter to store.

The FM7 Stock program list (with your machine, also available on our website, www.bandctech.com) is of great use when customizing and creating wash programs.

There are many built in cycles available for use or modification in custom programs. Here some commonly used cycles:

Spin9: Drain routine - used after each bath cycle, but not prior to the final spin.

Spin1: Low speed extract, 30 seconds

Spin2: Medium speed extract, 5 minutes.

Spin3: High speed extract, 5 minutes.

Note: Intermediate spins are not recommended - if the FM7 cannot achieve a good balance, the program will be terminated.

Note: Modifying the stock spin routines can cause the machine to not extract - proceed with caution.

Programming

Cycle Programming

Cycle libraries can be created for later use in the Wash programming step. When the machine is stopped, press the START and RESET buttons together. The display is:

n?

Using the keypad, type 12 and press ENTER. For two seconds, the display shows:

EDIT CYCLES>

The message for choosing the programming cycle is then displayed:

PREWASH = ?

Pressing INC or DEC will show the other cycle types in succession:

WASH = ?

SPIN = ?

RINSE = ?

UNROLL = ?

When the cycle type you wish to edit is displayed, press ENTER to begin creating or editing of the cycle. As an example, we will go through programming a Prewash cycle.

PREWASH = ?

Using the numerical keypad, enter the cycle you wish to create or modify. After you have entered the number and pressed ENTER, there are two possible cases:

- ▶ The cycle chosen does not exist and has to be programmed. (This Page)
- ▶ The cycle chosen does exist. If this is the case, you can view and modify the cycle as needed. (See page 17, and charts beginning on page 11).

New Cycle Creation

If the cycle you chose does not exist, you will be taken directly into the programming mode. For two seconds, the display will show:

START STEP 1

The display then changes to:

COOL DOWN? --

You can now define for step 1 whether the cool down feature is activated. If you wish to activate cooldown, press ENTER, and the display changes to:

COOL DOWN? ON

To implement the cooldown phase, five additional parameters must be entered. These are discussed in the next section. If you do not wish to activate the cooldown phase, press INC. The display will show:

FILL TO TEMP? --

You can now define for step 1 whether Fill to Temperature is enabled. A target temperature can be programmed and the machine will use a combination of the hot water fill valve and the cold water fill valve to maintain a given temperature. If you wish to activate temperature controlled fill, press ENTER. The display will change to:

FILL TO TEMP? ON

To implement temperature controlled fill, four additional parameters must be entered. These are discussed in the next section. If you do not wish to activate temperature controlled fill, press INC. The display will show:

DRAIN? --

Programming

Cycle Programming continued

To activate the Drain and end Step 1, press ENTER. Pressing INC or DEC will scroll through the other functions to end the step. The step can end with a Water Level, a Water Temperature, or an elapsed Time. Select one of the functions by pressing ENTER changes the display and prompts you to enter a value for the particular function.

Example

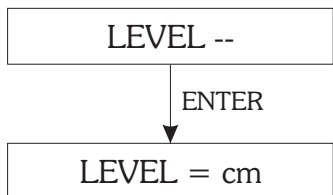

Type the required value in using the numerical keypad and press ENTER.

In the event that you choose a level or a temperature to end the step, you will be prompted with:

WDT = --

This is the Watch Dog Timer. Press ENTER to set the value.

WDT = m

Set the time in minutes, press ENTER

WDT = s

Set the time in seconds, press ENTER. This is a time limit in which the temperature or water level you have programmed should be reached. If the level or temperature cannot be reached in the given amount of time, the control will display an alarm. Press ENTER to continue after an alarm. Be sure to enter a time that is reasonably longer than the presumed time for filling or heating. 9:00 (nine minutes, zero seconds) is good for a fill, 30:00 (thirty minutes, zero seconds) is good for a heat step.

The display now shows:

SAVE?

Pressing STOP will cancel the programming and abort any parameters you have entered. To save, press ENTER. Now the start of a new step will be indicated. For two seconds the display shows:

START STEP 2

The display then changes to:

COOL DOWN? --

At this point, you may continue adding steps to the cycle using the same programming sequence as used for Step 1. If programming is complete, press STOP. The display now shows:

PREWASH = ?

You may now program another Prewash cycle, or select one of the other cycle types and continue programming. To exit from cycle programming, press RESET.

Cooldown Phase

The cooldown phase allows you to specify a temperature to reach before draining the machine. There are five parameters to be programmed: Minimum Level, Maximum Level, Temperature, WDT, and Agitation. The cooldown phase operates as follows:

- ▶ The water is drained to the minimum level as mentioned above.
- ▶ Cold water is then added up to the maximum level as mentioned above, and the temperature is monitored.
- ▶ Draining and filling continue until either the temperature is reached, or the WDT (watch dog timer) has expired.

The motor profile chosen is active throughout this step.

Programming

Cycle Programming continued

Temperature Controlled Fill

Cold and Hot water are added to the machine while the temperature and level are monitored. Four parameters must be entered: Level, Temperature, WDT, and Agitation. The option functions as follows:

Cold or Hot water is added to the machine depending upon the temperature set (Hot if the water temperature is lower than programmed, or Cold if it is higher) until the programmed water level is reached. Then the next step of the cycle can begin. During this phase, the WDT (watch dog timer) is active, which will flag a fault if the fill time is longer than the programmed WDT. The chosen motor routine is active for this entire process.

Heating

Throughout the programming of the steps, when heating is inserted, this tells the control to regulate the temperature. In a step that ends with a required temperature, the heating value must be greater than or equal to the step ending temperature. For example, if 50 degrees was set for heating, but 70 degrees was required to end the step, the machine could never reach 70 degrees, causing a fault from the Watch Dog Timer. In cases where the step is ended by time or level, the temperature can be selected from 30 to 93 degrees C. See Appendix A for details on building a Prewash, Wash, or Rinse cycle that uses heating.

Agitation

For the agitation function, after pressing ENTER, you are asked to enter the agitation (programmed earlier, see pages 8-10). When you have confirmed the selection with ENTER, the display shows:

RPM =

Enter the desired value and press ENTER to confirm. In Prewash, Wash, Rinse, and Unroll, the maximum speed is 100 RPM.

Programming Sequence

For Prewash, Wash, Rinse and Unroll, the programming sequence is as follows:

- ▶ Cooling
- ▶ Temp Controlled Fill
- ▶ Drain
- ▶ Cold Water
- ▶ Hot Water
- ▶ Heating
- ▶ Chem 1
- ▶ Chem 2
- ▶ Chem 3
- ▶ Chem 4
- ▶ Chem 5
- ▶ Aux 1
- ▶ Aux Fill
- ▶ Aux 2
- ▶ Spin Test
- ▶ Agitation
- ▶ Chem 6
- ▶ Chem 7
- ▶ Chem 8
- ▶ Drain B
- ▶ Aux 3
- ▶ Signal
- ▶ Aux 4
- ▶ Aux 5

Programming

Cycle Programming continued

Editing an existing cycle

If the cycle you chose already exists, the display will show:

NOT BLANK!

At this point, four choices are possible:

- 1 Choose another cycle by pressing STOP
- 2 Access the existing cycle by pressing ENTER (to edit step 1), or press ADVANCE to edit other steps. In this case, INC or DEC will display the various segments, and the configuration can be modified by using the ENTER and RESET keys to enable/disable a function, or using ENTER to modify any numerical value (RPM, Time, etc.) as described in the previous section.
- 3 Insert one or more steps. To do so, scroll through the steps by using the ADVAN key. The display will show START STEP X for two seconds, followed by NOT BLANK! To insert a step, press INS. The new step is inserted as the current step, and all later steps are increased by one. For instance, if the display showed Start Step 2 existing, and the INS key is pressed, a new step 2 is created, and the old step 2 is now step 3, the old step 4 is now step 5, etc. and the display changes to:

START STEP x

Followed by:

COOLDOWN? --

You may now proceed to program the new step using the techniques described earlier. After confirming storage of the new steps, press STOP.

- 4 Remove one or more of the steps from the existing ones. Proceed by pressing ADVAN as describe above in (3). When the message

NOT BLANK!

appears after the step you wish to remove, press the DEL key. The following message appears:

DELETE?

To confirm deletion of the step, press the ENTER key or press RESET to cancel the operation. After confirmation, press the STOP key to exit.

Each cycle can comprise a maximum of 100 steps.

A total of 400 steps can be programmed.

See the FM7 Stock Programs Listing, included with your machine, or available from our website (<http://www.bandctech.com>) for details of the cycles included with your machine from the factory.

Note: The factory programs and cycles can be altered at will. There is no way to restore the factory programming without manually inputting them, or via download with the FM7 programming software, also available for download on our website.

Programming

Example Cycle

The figure at the right shows a typical fill bath.

Step 1 - Fill to a water level with hot water. Watchdog timer of 9:00 allows time to fill before an alarm is generated. Step 1 ends when the water level is reached.

Step 2 - Chemical 2 output is on, Relay 12 (injection flush) is on (not required for machines with plastic vacuum breaker). Step 3 ends when a time of 1:00 elapses.

Step 3 - Top off step, same as step 1, except for a shorter Watch Dog Time.

Step 4 - This is the wash step. No relays/outputs are on. Step 4 and the entire cycle are complete when a time of 7:00 elapses.

A note about the Watch Dog Timer: The Watch Dog Timer makes sure that the machine reaches level or temperature in a timely fashion, and ensures that the water or heat doesn't stay on until someone notices a problem. Don't be confused - Step 1 will end when the programmed water level is reached, NOT when 9 minutes has elapsed.

Function	Step			
	1	2	3	4
Cool Down				
Fill to Temp				
Drain				
Cold Water				
Hot Water	Yes		Yes	
Heating				
Chem 1				
Chem 2		Yes		
Chem 3				
Chem 4				
Chem 5				
Aux 1				
Aux Fill				
Aux 2				
Spin Test				
Agitation	1	1	1	1
Speed RPM	42	42	42	42
Chem 6				
Chem 7				
Chem 8				
Drain B				
Aux 3				
Signal				
Aux 4				
Aux 5				
End Step				
Level cm	24		24	
Temp C				
WDT m:s	9:00		5:00	
Time m:s		1:00		7:00

Programming

Wash Program Creation

When the machine is stopped, press the START and RESET buttons together. The display is:

n?

Using the keypad, type 27 and press ENTER. For two seconds, the display shows:

EDIT PROG. No.

At this prompt, type the program number you wish to create or edit, followed by the ENTER key. Again, two situations are possible:

- ▶ The Program does not exist and must be created.
- ▶ The Program already exists and can be viewed and modified.

Creating a new Wash Program

The display reads

NOT FOUND!

for two seconds, then:

C1>?

At this prompt, press ENTER. The display changes to:

C1>PREWASH = ?

Using the INC or DEC key, you can select the type of cycle to insert: Prewash, Wash, Spin, Rinse, and Unroll. For example, if you wish to insert a wash cycle you have named 3, press INC until the display changes to:

C1>WASH = ?

Confirm the selection by pressing ENTER. The display changes to:

C1>WASH = No.

Type 3 on the keypad, the press ENTER. Wash 3 is now stored as the first segment of the program. The display will prompt you to enter a second cycle:

C2>?

At this prompt, press ENTER. The choice of cycle will be displayed as previously. Programs can be compiled with up to 15 cycles chosen from those in available in the cycles library (see the FM7 Stock Programs Listing). The same cycle can be used repeatedly in a wash program. After you are through programming, and have confirmed the last cycle, press STOP to terminate programming. The display then shows:

SAVE?

Press ENTER to store the program. Press RESET to cancel and return to the beginning. If while programming, you enter a wash cycle that does not exist, the following message will appear:.

NOT FOUND!

Since the wash cycle doesn't exist, you will have to create it before adding it to a wash program.

Editing an Existing Program

In the event the wash program already exists, the display will change to:

NOT BLANK!

for two seconds, followed by the display of the program contents. For example:

C1>RINSE = 1

By using the INC or DEC keys, the various cycles comprising the wash program can be viewed. The program can be modified, and cycles can be added or deleted.

Deleting a Cycle

Using the INC and DEC keys, find the cycle you wish to delete. While the cycle is displayed, press the delete key, then press the

Programming

Wash Program Creation continued

STOP key when the display changes to:

SAVE?

Confirm by pressing the ENTER key. The cycle in question will be deleted, and the cycles following will be decremented by one.

Inserting a Cycle

To insert a cycle, use the INC and DEC keys to find the cycle that will follow the cycle you are about to insert. The new cycle will be inserted just before the cycle displayed. Now press the INS key, the request to enter a new cycle will be displayed:

C -> ?

Press ENTER to confirm that you wish to insert a new cycle:

Cn> PREWASH=?

Use the INC and DEC keys to go to the required cycle type and press ENTER to confirm. You will then be asked to enter the cycle number:

Cn> PREWASH=N

After entering the cycle number and pressing the ENTER key, you can leave programming by pressing STOP. The display changes to:

SAVE?

Press the ENTER key to store the altered program. All the following cycles will be incremented by one. If you don't want to change the program, press the RESET key rather than the ENTER key. This will cancel all modifications made.

See the FM7 Stock Programs Listing, included with your machine, or available from our website (<http://www.bandctech.com>) for details of the cycles included with your machine from the factory.

Note: The factory programs and cycles can be altered at will. There is no way to restore the factory programming without manually inputting them, or via download with the FM7 programming software, available on the technical service page of our website.

Programming

Wash Program Creation continued

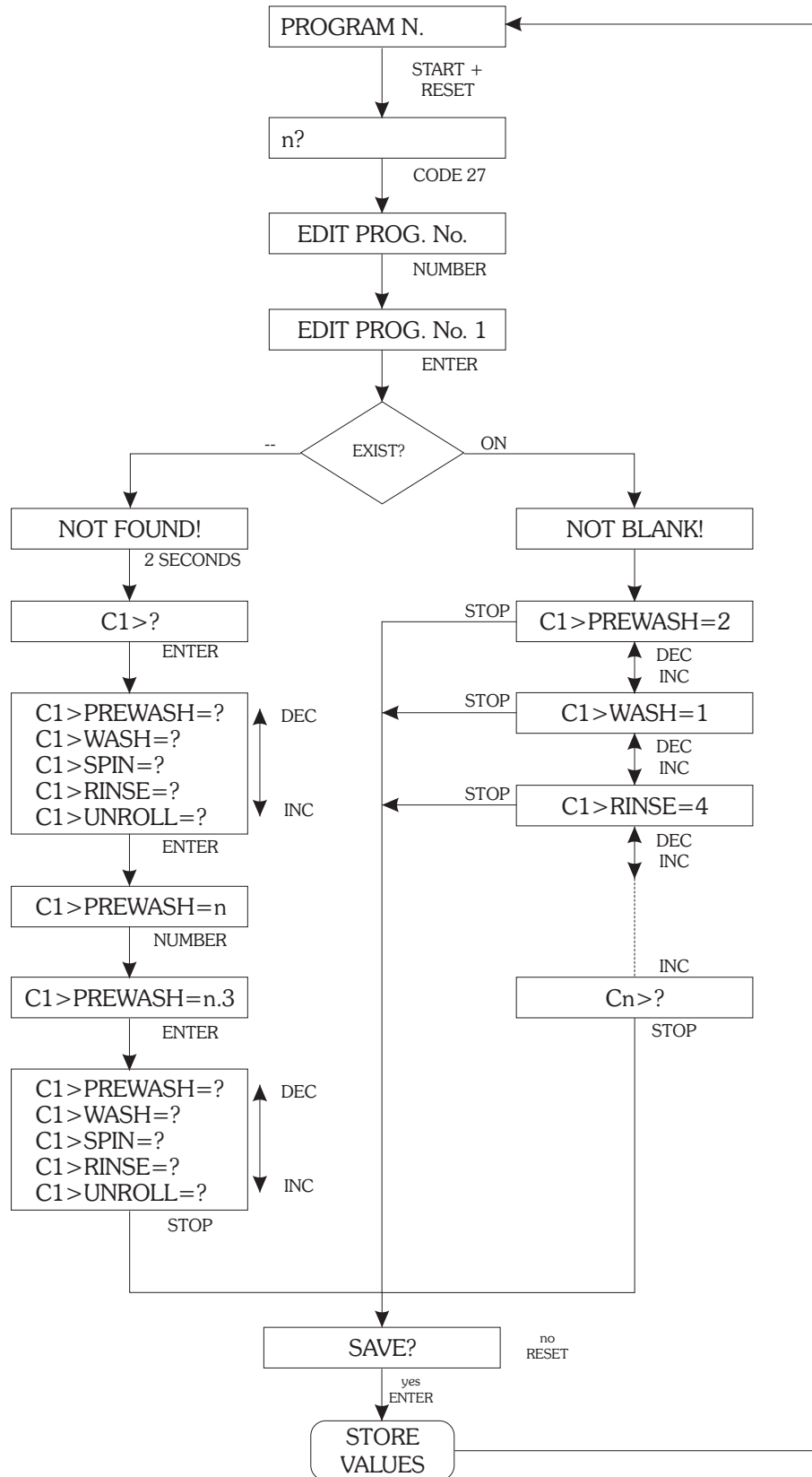

Execution

Wash Program Execution

After power is applied to the machine, and the internal diagnostics are complete, the machine is ready for a program to be chosen. The display will show:

ENTER PROG>

Using the keypad, type the number of the program you wish to run followed by the ENTER key. The display will change to show the first cycle of the selected program:

PRWH 1 EXECUT.?

Press START to execute the program, or RESET to return to program selection. While the program is executing, the display shows the current segment of the program, and the ending condition of the segment. See the following examples:

Level

If the end requirement of the segment (cycle) is a particular water level, the display will show:

RINSE1 LVL=cm12

cm12 is the actual water level in the machine (12 centimeters). Pressing the LEVEL key shows, for 3 seconds, the required value to advance. If INC or DEC is pressed, you can temporarily modify the value for the current step. Pressing TEMP allows you to see the current temperature of the water. Pressing the TIME key shows the watch dog timer (WDT) value for the current step.

Temperature

If the end requirement of the segment is a particular temperature, the display will show:

WASH3 TEMP = 35C

where 35C is the actual temperature of the wash solution. By pressing TEMP the display

will change, for 3 seconds, show the required step temperature for advance. Pressing INC or DEC allows modification of the value for the step. Pressing LEVEL allows you to see the current water level. Pressing the TIME key shows the watch dog timer (WDT) value for the current step.

Time

If the end of the step calls for a time to elapse, the display shows:

RINSE1 T = 2m 30s

In this case, the display shows the remaining time left in the step. INC and DEC allow you to add or subtract minutes for the current cycle. TEMP allows you to view the current water temperature, and LEVEL shows the current water level.

Note: During heating, fill and drain phases, the WDT (watch dog timer) is activated. If the phase does not complete before the timer expires, an alarm will be displayed indicating that the particular phase did not complete within the maximum time allowed.

Single Step Execution

A single step or cycle of a wash program can be executed. At the main prompt, enter zero for the program number. For two seconds, the display changes to:

MANUAL MODE

Then, using the INC and DEC keys, you may choose the cycle you wish to run (PREWASH, WASH, RINSE, SPIN, UNROLL). When you have selected your cycle, confirm by pressing ENTER. The display changes to:

PRWH 1 EXECUT.?

Pressing the START key will start the machine.

Execution

Wash Program Execution

Partial Program

A program can be partially run. After selecting the program you wish to execute, the display will show:

PRWH 1 EXECUT.?

Instead of pressing ENTER to execute the program, press the ADVAN key. The cycles within the program will be displayed incrementally. Choose the point at which you would like to begin, and press the START key. The machine will begin operation from this point.

Displaying the Current Program and Step

While the machine is in operation, pressing then ENTER key will cause the display to show the current program number and step.

PRG 1 STP 3

Soak

You can insert a pause at any point of the wash program with the exception of distribution and spin. To do so, simply press the PAUSE key. The display will begin showing a time, counting up as long as the machine remains paused. Pressing the START key will restart the program at the point it was paused. As long as the machine is paused, all other WDT (watch dog timers) are paused as well.

Advance

While any program is running, you can end the current step and advance to the next one by pressing the ADVAN key. If the key is pressed during a spin, the spin will be aborted, and the standard spin slow down time will be activated.

Halting a Program

At any time during the execution of the wash program, the running program can be terminated by pressing the STOP key.

Water Level Refresh

While a program is running, if the water level drops to a level which is 3cm below the target level, cold water will automatically be added to replenish the level.

Spin Retry

If, during a spin segment, the load is excessively out of balance, the spin will stop, and a redistribution of the goods will take place. If three consecutive out of balances occur, the machine will end the program.

Power Failure

If the power fails during execution of a program, and is of less than one second, it is ignored. If the failure is longer than one second, the machine stops. Upon restoration of mains power, the display shows CYCLE CONTINUE? If you wish to restart the program at the point in which power failed, press the START key. At this point, the program restarts at the point of power failure and the power failure indicator turns off. If you wish to cancel the program, simply press the RESET key. This function is not active while a single cycle is running.

End of Program

When a program has completed, the message PLEASE WAIT is displayed and the buzzer sounds for a minimum of 90 seconds. Then, if the water level is lower than 3cm and the temperature is lower than 40C, the door may be opened. The buzzer can be silenced by pressing the RESET key. If the temperature or water level are too high, the display shows the offending value and the door cannot be opened.

Execution

Wash Program Execution

Malfunction Alarms

The state of the water temperature and water levels are constantly monitored to prevent functioning problems with these devices. Watch Dog Timers (WDT) are used to prevent cycle failure when temperatures, fills, drains, and levels don't meet programmed values. In the event of a program fault, the buzzer sounds and the display changes to show the fault:

LEVEL ALARM

Indicates a problem with the level sensing system. This could be a loose or cracked water level tube, the level sensor, or the level sensing circuit. As long as the system detects a problem with the level sensing system, the machine will be inoperable. The buzzer can be disabled with the RESET key.

TEMP ALARM!

Indicates a problem with the temperature sensing circuitry, temperature probe, or wiring. The machine continues to function, although auxiliary heating (if equipped) is not possible. The Temperature fault indicator on the control panel will be illuminated.

TEMP WDT!

Indicates the programmed temperature was not reached within the allotted time. The most common cause is a malfunctioning auxiliary heating system. A short WDT time and very cold water can also cause this problem. Pressing the START key will cancel the alarm.

FILL WDT!

Indicates the programmed level was not reached within the allotted time. The most common causes:

During Fill

- ▶ Faulty water inlet valve
- ▶ Low or no water pressure

- ▶ Faulty drain valve
 - ▶ Problem with water level tube
- Pressing START will continue the program, while RESET will cancel the program.

During Drain

- ▶ Drain valve blocked
 - ▶ Drain hose blocked
 - ▶ Faulty Drain Valve
- Press RESET to end the program.

VFD FAULT!

Indicates a fault in the drive system. On inverter driven equipment, indicates a drive fault. Press RESET to clear the fault. If this fault recurs during the next wash program, contact a qualified service technician.

DOOR ALARM!

Indicates the door is not closed properly. This fault disables the machine until cleared, and aborts a program if active. Press RESET to clear the fault.

DRAIN

Indicates a water level of greater than 2cm at the onset of spin. The machine will resume the spin when the level falls below the threshold. Press RESET to abort the cycle.

LEVEL cm=xx

Indicates water level in the cylinder at the end of a program. If no water is present, ensure that the water level pickup tube is clean and free of debris, and that no debris is built up around the opening in the sump where the tube is connected. After cleaning, open the door, power the machine down for 5 minutes, restore power, and wait 5 minutes (with the door open). Then simultaneously press START and STOP. This will reset any offset that has developed due to level tube restriction.

Service Functions

Access Functions

All machine functions are accessed by pressing START and RESET simultaneously. At the changed prompt, key the required function, then press ENTER.

- 12 Cycle (segment) Programming
- 27 Wash Programming
- 45 Agitation programming
- 144 Enables the FM7 communication mode so that programs can be downloaded and uploaded to the control.
- 181 Clears all programs. Will delete anything programmed in memory.
- 201 Language: 1 - Italian, 2 - English, 3 - German, 4 - Spanish, 5 - French.
- 205 16 or 24 relay output board (B&C equipment uses the 24 relay version).
- 207 Maximum RPM - DO NOT MODIFY!
- 209 Temperature hysteresis (1 - 10 degrees C). 3 degrees C is default.
- 210 Temperature displayed in degrees C
- 211 Temperature displayed in degrees F
- 212 Maximum water level (10 - 100cm)
- 213 Minimum water level for heating (2 - 30cm)
- 214 Display number of hours in operation
- 215 Display total number of programs run
- 216 Display number of wash programs run since last maintenance request.
- 217 Reset Service Alarm
- 218 Display and set the number of washes between service alarms.
- 219 Coast down safety timer. DO NOT MODIFY!
- 220 Deletes all programs and cycles from memory.
- 221 Copy from control to the memory card
- 222 Copy from memory card to the control (programs and cycles only)
- 223 Copy from memory card to the control (programs, cycles and parameters)
- 225 Disables the ADVANCE key
- 230 Maximum water level allowed during spin DO NOT MODIFY!

Service Alarm

After 450 wash programs have completed, the machine will call for maintenance:

SERVICE ALARM!

The message appears at the start of a program, and is repeated at the beginning of each wash program until reset (see function 217, pg 26).

Disable the Machine

Function 118

Upon entering this function, the machine will not operate. The power must be cycled (turned off, then back on) for the function to activate. Upon power up, the display will show:

!

To re-enable the machine, press, then release the Emergency Stop Button, then type 118. **START + RESET is not needed.**

Change Language

Function 201

The control can display in 5 different languages. To change the language, use function 201. Upon entering the function, the display changes to:

LANGUAGE

Type the number which corresponds to your language, followed by ENTER:

- 1 - Italian
- 2 - English
- 3 - German
- 4 - Spanish
- 5 - French

16 or 24 Relays

Function 205

Each time function 205 is entered, the controller toggles between 16 and 24 relay setup. After entering 205, the display shows the current mode. B&C uses 24 relays.

Service Functions

Access Functions continued

Maximum Spin Speed

Function 201

This function allows you to display or modify the maximum spin speed. Upon entering the function, the display will show the current value. To exit without changing, press RESET. If you wish to change the value, press ENTER, type the new value, and press ENTER again. If the value is within the acceptable range, the display will show ON. Otherwise, the display will show --. Do not modify unless instructed by B&C Technologies!

Temperature Hysterisis

Function 209

This function sets the allowed temperature variation parameter. The default value is 3 degrees. If you wish to change the value, press ENTER, key in the new value (1 - 10 degrees C), then press ENTER again to confirm. To exit without changing, press RESET.

Temperature Display

Function 210

Function 211

During program execution, the temperature may be displayed in degrees Fahrenheit or degrees Centigrade. For degrees F, enter function 211. For degrees C, enter function 210. Please note that this is for display only. Programming is always done in degrees C. See the handy conversion chart in the back of this manual.

Maximum Water Level

Function 212

This function allows display and modification of the maximum programmable water level. To change the value, press ENTER, type in the new value, and press ENTER again to confirm. To exit without modification, press RESET. The allowable values are 11 to 100 cm. Do not modify unless instructed by B&C Technologies!

Minimum Level for Heat

Function 213

This function sets the minimum allowable water level for heat to activate. Upon entering the function, the value will be displayed. To modify, press ENTER. Type the new value, and press ENTER again to confirm.



DO NOT MODIFY WITHOUT CONSULTING B&C TECHNOLOGIES OR A QUALIFIED SERVICE TECHNICIAN! EXTREME MACHINE DAMAGE CAN OCCUR!

Hours of Work

Function 214

Entering function 214 displays the total number of hours the machine has operated. The display shows the value for about 3 seconds. Only complete cycles are counted for this timer - partially complete cycles are not counted as part of the total work time.

Total Number of Washes

Function 215

This function shows the total number of wash programs executed since the machine was installed.

Number of Washes since last Maintenance

Function 216

This function shows the total number of wash programs executed since the last required maintenance was performed (set with function 218).

Reset Maintenance Alarm

Function 217

This function resets the maintenance alarm, but does not clear the number of washes counter (function 215). Before resetting the alarm, **PERFORM ROUTINE MAINTENANCE AS OUTLINED IN THE OPERATION MANUAL.**

Service Functions

Access Functions continued

Service Alarm

Function 218

This function sets the number of washes before the service alarm is activated. The default value is 450. This means that after 450 wash programs have been completed, the service alarm will be displayed. To change the value, use the INC or DEC keys. The value changes by 10 each time a key is pressed. You may hold down the key to change the number quickly. Once the desired value is reached, press the ENTER key to confirm.

Spin Safety Coast Down Time

Function 219

Upon entering function 219, you display the spin safety coast down time. If you wish to change this (not recommended), press ENTER, followed by the new value, then ENTER to confirm. To exit without changing the value, press RESET.



DO NOT MODIFY
WITHOUT CONSULTING
B&C TECHNOLOGIES!
EXTREME MACHINE
DAMAGE AND PERSONAL
INJURY CAN OCCUR!

Memory Erasure

Function 181

Function 220

Partial or total clearing of the control memory is possible. Function 220 clears all programs and cycles, but machine parameters are not erased. Function 181 erases all programs and cycles, and also erases all machine parameters, thus reinitializing the control. After keying in the function, the display reads: "DELETE E2PROM?" Press ENTER to confirm. Press RESET to abort the procedure.

Disabling the Advance Key

Function 225

This function disables the ADVAN key. This function toggles between enabled (ON) and disabled (--). Default value is enabled (ON).

Maximum Level in Spin

Function 230



This function sets the maximum water level during execution of a spin. If you do not wish to modify the value, press RESET. If you want to modify the value, press ENTER, followed by the new value, then ENTER again to confirm. Allowed values are from 2 to 60 cm.

DO NOT MODIFY WITHOUT CONSULTING
B&C TECHNOLOGIES OR A QUALIFIED
SERVICE TECHNICIAN! EXTREME
MACHINE DAMAGE CAN OCCUR!

Software Version

STOP + RESET

Pressing the STOP and RESET keys simultaneously displays the installed firmware version.

Cylinder Speed

INS

Pressing the INS key during execution of a wash program displays the commanded wash cylinder speed in RPM.

Metric Conversions

Fahrenheit to Centigrade

F	C	F	C	F	C
86	30	129.2	54	172.4	78
87.8	31	131	55	174.2	79
89.6	32	132.8	56	176	80
91.4	33	134.6	57	177.8	81
93.2	34	136.4	58	179.6	82
95	35	138.2	59	181.4	83
96.8	36	140	60	183.2	84
98.6	37	141.8	61	185	85
100.4	38	143.6	62	186.8	86
102.2	39	145.4	63	188.6	87
104	40	147.2	64	190.4	88
105.8	41	149	65	192.2	89
107.6	42	150.8	66	194	90
109.4	43	152.6	67	195.8	91
111.2	44	154.4	68	197.6	92
113	45	156.2	69	199.4	93
114.8	46	158	70	201.2	94
116.6	47	159.8	71	203	95
118.4	48	161.6	72	204.8	96
120.2	49	163.4	73	206.6	97
122	50	165.2	74	208.4	98
123.8	51	167	75	210.2	99
125.6	52	168.8	76	212	100
127.4	53	170.6	77		

Metric Conversions

Centimeters to Inches

cm	in	cm	in	cm	in	cm	in	cm	in
1	0.39	21	8.27	41	16.14	61	24.02	81	31.89
2	0.79	22	8.66	42	16.54	62	24.41	82	32.28
3	1.18	23	9.06	43	16.93	63	24.8	83	32.68
4	1.57	24	9.45	44	17.32	64	25.2	84	33.07
5	1.97	25	9.84	45	17.72	65	25.59	85	33.46
6	2.36	26	10.24	46	18.11	66	25.98	86	33.86
7	2.76	27	10.63	47	18.5	67	26.38	87	34.25
8	3.15	28	11.02	48	18.9	68	26.77	88	34.65
9	3.54	29	11.42	49	19.29	69	27.17	89	35.04
10	3.94	30	11.81	50	19.69	70	27.56	90	35.43
11	4.33	31	12.2	51	20.08	71	27.95	91	35.83
12	4.72	32	12.6	52	20.47	72	28.35	92	36.22
13	5.12	33	12.99	53	20.87	73	28.74	93	36.61
14	5.51	34	13.39	54	21.26	74	29.13	94	37.01
15	5.91	35	13.78	55	21.65	75	29.53	95	37.4
16	6.3	36	14.17	56	22.05	76	29.92	96	37.8
17	6.69	37	14.57	57	22.44	77	30.31	97	38.19
18	7.09	38	14.96	58	22.83	78	30.71	98	38.58
19	7.48	39	15.35	59	23.23	79	31.1	99	38.98
20	7.87	40	15.75	60	23.62	80	31.5	100	39.37

Blank Programming Chart

Prewash:

Wash:

Rinse:

Spin:

Unroll:

	Step																					
Function	1	2	3	4	5	6	7	8	9	10	11	12	13	14	15	16	17	18	19	20	21	22
Cool Down																						
Fill to Temp																						
Drain																						
Cold Water																						
Hot Water																						
Heating																						
Chem 1																						
Chem 2																						
Chem 3																						
Chem 4																						
Chem 5																						
Aux 1																						
Aux Fill																						
Aux 2																						
Spin Test																						
Agitation																						
Speed RPM																						
Chem 6																						
Chem 7																						
Chem 8																						
Drain B																						
Aux 3																						
Signal																						
Aux 4																						
Aux 5																						
End Step																						
Level cm																						
Temp C																						
WDT m:s																						
Time m:s																						

Cool Down	
Level min	cm =
Level max	cm =
Temperature	C =
WDT m:s	:

Temperature Controlled Fill	
Level	cm =
Temperature	C =
WDT m:s	:

Heating	
Temperature	C =

Notes:

Water Level Guide

Machine	Low 15%		Med 25%		High 35%	
	cm	in	cm	in	cm	in
HE-35	15	6.0	21	8.4	27	10.8
HE-45	16	6.4	23	9.1	30	11.8
HE-65	18	7.0	26	10.1	34	13.2
HE-85	20	7.8	29	11.5	38	15.1
HE-110	21	8.2	31	12.0	40	15.9
SP-40,45,50	16	6.4	23	9.1	30	11.7
SP-60,65,75	18	7.0	26	10.1	34	13.2
SP-100,110	20	7.9	30	11.6	39	15.3
SP-130,135	22	8.7	33	12.9	43	17.1
SP-155,165	22	8.8	33	13.1	44	17.4
SP-195	28	10.9	39	15.5	51	20.1
SI-110	24	9.5	34	13.2	43	16.9
SI-135	26	10.4	37	14.7	48	19.0
SI-200	28	10.8	39	15.4	51	20.0
SI-275	30	11.7	43	16.9	56	22.1
SI-300	30	11.7	43	16.9	56	22.1
SI-450	34	13.6	51	20.0	67	26.4
HP-60,65	18	7.0	26	10.1	34	13.2
HP-85	24	9.3	33	12.9	42	16.5
HP-125	26	10.2	37	14.4	47	18.5
SB-60	18	7.0	26	10.1	34	13.2
SB-80	18	7.0	26	10.1	34	13.2
SB-155	26	10.3	37	14.5	47	18.7
SB-225	26	10.3	37	14.5	47	18.7
SB-300	28	11.0	40	15.7	52	20.5
SB-485	31	12.2	45	17.7	59	23.2

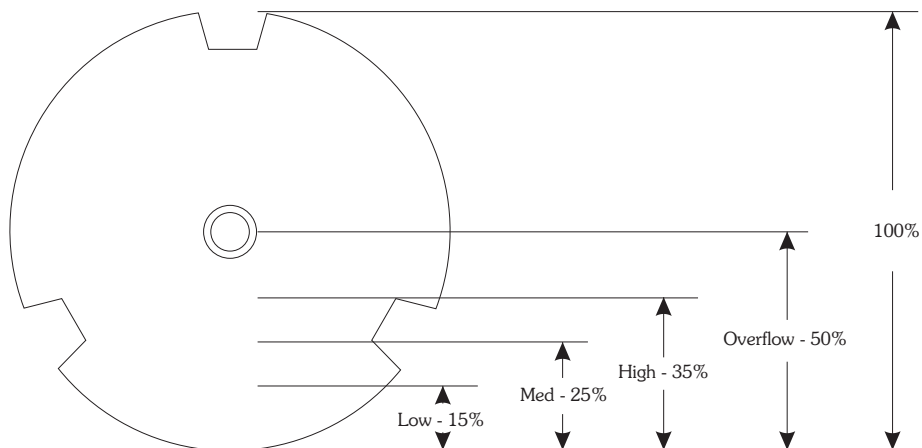

RPM-G Force Guide

Machine						Low	Med	High				
	0.4 G	0.8 G	1.0 G	1.5 G	3.0 G	50 G	150 G	200 G	300 G	320 G	350 G	
HE-35	34	48	54	66	94	382	662	765				
HE-45	32	46	51	63	89	362	627	724				
HE-65	30	43	48	58	82	337	583	673				
HE-85	28	39	44	54	76	311	539	622				
HE-110	27	38	43	52	74	302	523	604				
SP-40,45,50	32	46	51	63	89	363	628	726	889	918	960	
SP-60,65,75	30	43	48	58	82	337	583	673	824	852	891	
SP-100,110	28	39	44	53	76	309	534	617	756	781	816	
SP-130,135	26	37	41	50	71	290	502	579	709	733	766	
SP-155,165	26	36	40	50	70	286	496	573	701	724	757	
SP-195	25	35	39	48	68	276	478	552	676	699	731	
SI-110	28	39	44	53	76	309	534	617	756	781		
SI-135	26	36	40	50	70	286	496	573	701	724		
SI-200	25	35	39	48	68	277	479	553	678	700		
SI-275	23	33	37	45	64	260	451	521	638	659		
SI-300	23	33	37	45	64	260	451	521	638	659		
SI-450	21	30	33	41	57	234	406	469	574	593		
HP-60,65	30	43	48	58	82	337	583	673	824			
HP-85	28	40	44	54	77	313	542	626				
HP-125	26	37	41	50	71	291	503	581				
SB-60	30	43	48	58	82	337	583	673	824	852	891	
SB-80	30	43	48	58	82	337	583	673	824	852	891	
SB-155	26	37	41	50	71	289	501	579	709	732	766	
SB-225	26	37	41	50	71	289	501	579	709	732	766	
SB-300	24	35	39	47	67	273	473	546	669	691	723	
SB-485	23	32	36	44	62	253	438	506	619	640	669	

EXTRACT RPM TO G-FORCE

Machine	50 G	75 G	100 G	125 G	150 G	175 G	200 G	225 G	250 G	275 G	300 G	325 G	350 G
HE-35	382	468	541	605	662	715	765						
HE-45	362	443	512	572	627	677	724						
HE-65	337	412	476	532	583	630	673						
HE-85	311	381	440	492	539	582	622						
HE-110	302	370	427	477	523	565	604						
SP-40,45,50	363	444	513	574	628	679	726	770	811	851	889	925	960
SP-60,65,75	337	412	476	532	583	630	673	714	753	789	824	858	891
SP-100,110	309	378	436	488	534	577	617	655	690	724	756	787	816
SP-130,135	290	355	410	458	502	542	579	614	648	679	709	738	766
SP-155,165	286	351	405	453	496	536	573	607	640	671	701	730	757
SP-195	276	338	390	437	478	517	552	586	617	648	676	704	731
SI-110	309	378	436	488	534	577	617	655	690	724	756		
SI-135	286	351	405	453	496	536	573	607	640	671	701		
SI-200	277	339	391	438	479	518	553	587	619	649	678		
SI-275	260	319	368	412	451	487	521	552	582	610	638		
SI-300	260	319	368	412	451	487	521	552	582	610	638		
SI-450	234	287	331	371	406	439	469	497	524	550	574		
HP-60,65	337	412	476	532	583	630	673	714	753	789	824		
HP-85	313	383	443	495	542	585	626						
HP-125	291	356	411	459	503	544	581						
SB-60	337	412	476	532	583	630	673	714	753	789	824	858	891
SB-80	337	412	476	532	583	630	673	714	753	789	824	858	891
SB-155	289	354	409	458	501	541	579	614	647	679	709	738	766
SB-225	289	354	409	458	501	541	579	614	647	679	709	738	766
SB-300	273	334	386	432	473	511	546	579	611	640	669	696	723
SB-485	253	310	358	400	438	473	506	536	565	593	619	645	669

Appendix A

Creating a Heat Cycle

Any cycle can be converted to a heating cycle by inserting a step after the fill, and setting the end step condition to a temperature (See Step 2 in the illustration to the right).

Step 1 - Fill to a water level with hot water. Heat is on, and will engage when a minimum water level is met. Watchdog timer of 9:00 allows time to fill before an alarm is generated. Step 1 ends when the water level is reached.

Step 2 - Heat output is on. Watchdog timer of 30:00 allows time to heat to the required temperature before an alarm is generated. Step 3 ends when the target temperature is reached.

Step 3 - Heat output is on, Chemical 2 output is on, Relay 12 (injection flush) is on (not required for machines with plastic vacuum breaker). Step 3 ends when a time of 1:00 elapses.

Step 4 - Top off step, same outputs as step 1.

Step 5 - Heat output is on in order to regulate temperature during the agitation phase. Step 5 and the entire cycle are complete when a time of 7:00 elapses.

Refer to the earlier sections in this manual for a full explanation of each step.

Function	Step				
	1	2	3	4	5
Cool Down					
Fill to Temp					
Drain					
Cold Water					
Hot Water	Yes			Yes	
Heating	Yes	Yes	Yes	Yes	Yes
Temperature	90	90	90	90	90
Chem 1					
Chem 2			Yes		
Chem 3					
Chem 4					
Chem 5					
Aux 1					
Aux Fill					
Aux 2					
Spin Test					
Agitation	1	1	1	1	1
Speed RPM	42	42	42	42	42
Chem 6					
Chem 7					
Chem 8					
Drain B					
Aux 3					
Signal					
Aux 4					
Aux 5					
End Step					
Level cm	24			24	
Temp C		90			
WDT m:s	9:00	30:00		5:00	
Time m:s			1:00		7:00

Appendix B

Chemical Hold Signal

The chemical hold interface on the FM7 is accomplished by connecting an external relay contact to the chemical hold input terminals in the machine. The electrical arrangement is as follows:

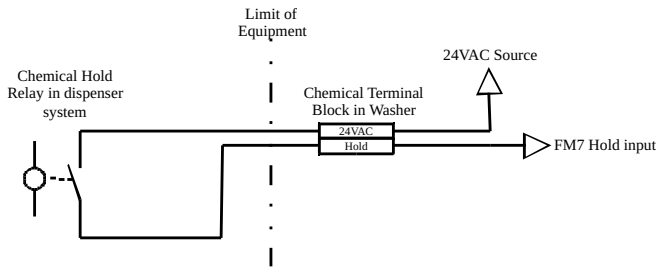

In operation, when the chemical hold relay is closed by the dispenser, the washer pauses and starts a hold timer. When the washer pauses water is retained in the cylinder, all water fill and chemical supply signals are turned off, and the FM7 displays “HOLD” followed by the minutes and seconds of the current hold time. When the chemical hold relay is opened by the dispenser, the washer will resume normal operation. Any chemical signal programmed to be on will turn back on, water fills and flushes turned on will turn back on and the bath will proceed as programmed. For example, if a chemical signal is programmed for 10 seconds and the hold input turns on after it has counted down to 9 seconds, then after the hold signal is turned off, the chemical signal will turn on and resume the 9 second count down before the program proceeds. For clarification, below is a timing chart:

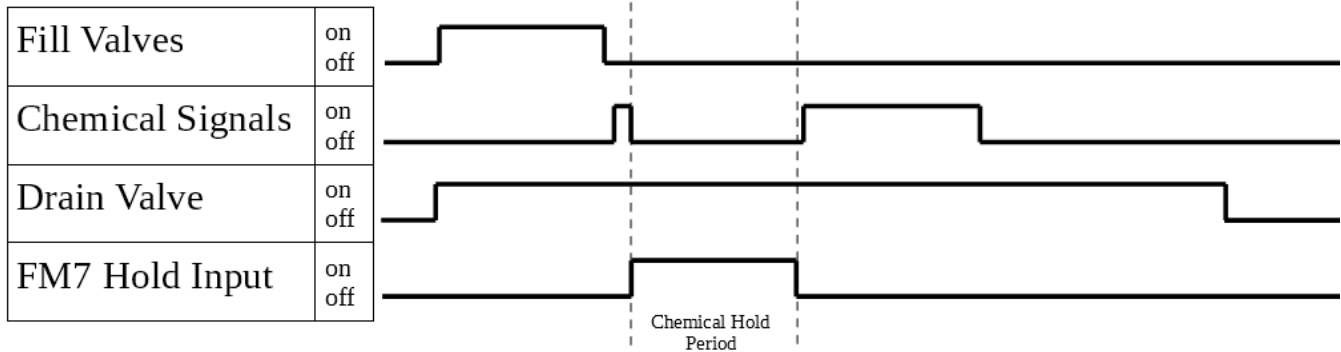

If the return of the chemical signal after the hold period presents a problem for the dispenser, then the signal can be programmed for a short time. If the dispenser needs to see the signal on during the hold period, then latching relays need to be used for the chemical interface, and an extra signal can be used as a signal “reset” at the end of the chemical period.

The FM7 does not monitor the chemical hold function when the machine is not running a wash program. So hold input state changes will have no effect if the machine is not running a wash program.

No special programming is required for the chemical hold function to operate as described.



More information is available on our website:
www.bandctech.com

©2016, B&C Technologies, LLC
All Rights Reserved
