

A

Front View

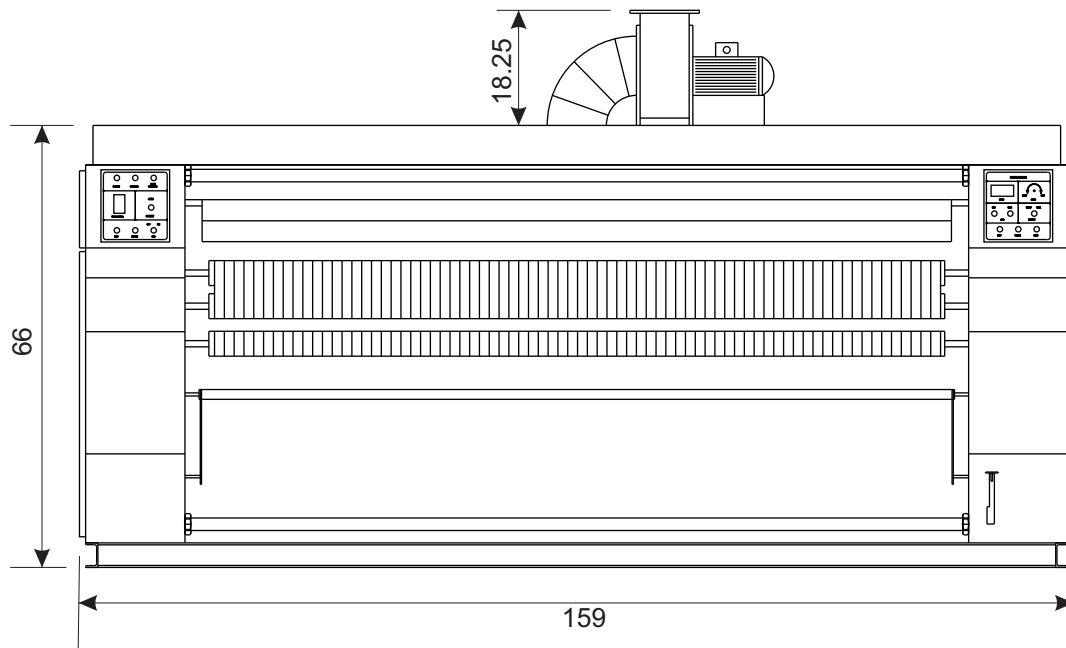

Side View

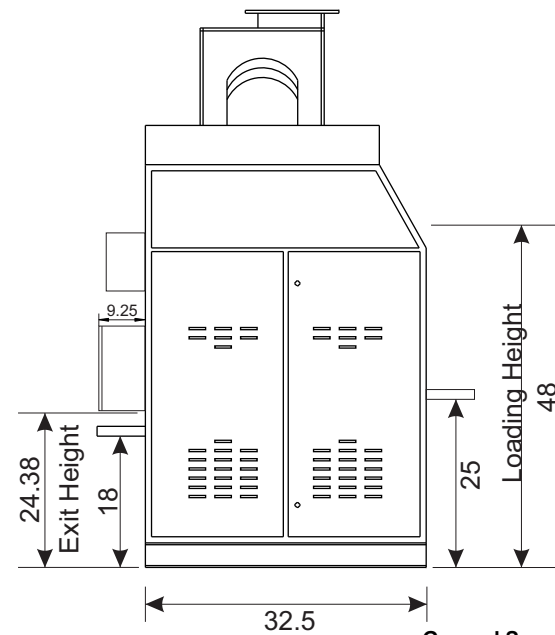

Exhaust Detail

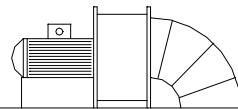
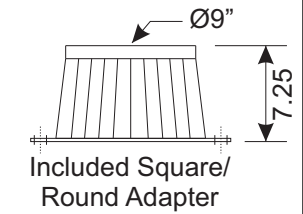
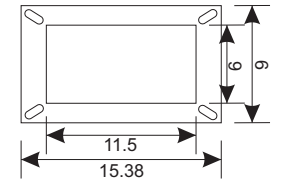

Rear View

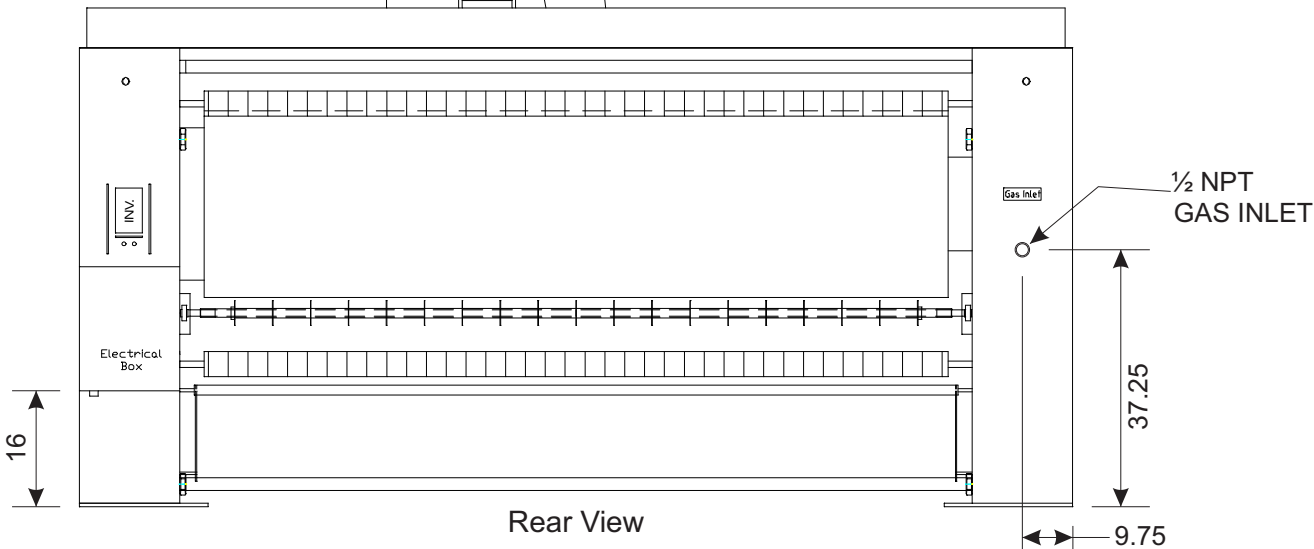

General Specifications

Model	Metric	US	IS-14120	
Number of Rolls	#		1	1
Roll Diameter	mm	inch	356	14
Working Width	mm	inch	3048	120
Speed Range	m/min	ft/min	2.5-11	8-36
Exhaust System				
Air Flow, Primary	cmm	cfm	30.5	1080
Exhaust Duct	mm	inch	228.6	9
Drive Information				
Drive Motor	kW	HP	0.75	1
Delivery Motor	kW	HP	0.25	1/3
Blower Motor, Primary	kW	HP	0.75	1
Steam				
Consumption		BHP	3.8	
Pressure	bar	psi	6.3-8.8	90-125
Inlet Size	mm	inch	19.1	0.75
Outlet Size	mm	inch	12.7	0.5
Gas				
Heat Input		BTU	260,000	
Gas Inlet Size	mm	inch	12.7	1/2
Electrical Service				
208-240VAC, 50/60Hz, 3PH	Amps	Breaker	8	15
380-480VAC, 50/60Hz, 3PH	Amps	Breaker	4	15
Weight & Shipping				
Net Weight	kg	lbs	1140	2508
Shipping Weight	kg	lbs	1290	2838

REV	BY	DATE	REV. DESCRIPTION
A1	AFA	12-13-2006	Created Drawing
DRAWN BY		DATE	 Panama City, FL Phone: 850-249-2222 Fax: 850-249-2226 www.bandctech.com
A. Adcock		12-13-06	
CHECKED BY		DATE	
C. Oswald		12-13-06	
DESCRIPTION			
General Technical Specifications			
IS-14120 Gas Ironer			
DATE	FILE NAME	SHEET	
12-13-2006	IS-14120 Layout.cdr	1 OF 1	